

# 7

## Sistemi di sicurezza

---

*Safety Systems*  
*Sicherheitssysteme*  
*Sistemas de seguridad*  
*Systemes de securite*

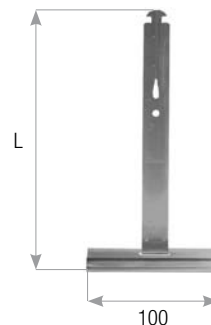
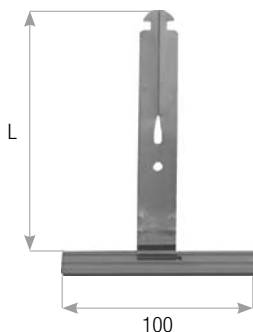

Molla di sicurezza **mini** testa a taglio  
Mini Cutting Head Safety Spring

cod.	L	descriz.   descrip.
<b>MGT.1130</b>	130mm	grezza (brut)
<b>MVT.1130</b>	130mm	verniciata (painted)
<b>MFT.1130</b>	130mm	floccata (flocked)
<b>MGT.1170</b>	170mm	grezza (brut)
<b>MVT.1170</b>	170mm	verniciata (painted)
<b>MFT.1170</b>	170mm	floccata (flocked)

**Dati tecnici | Technical data:**

**saldatura 4 punti | 4 points welding**

**materiale | material**  
acciaio inox + alluminio |  
inox stainless steel + aluminium



**500 p**

Molla di sicurezza **maxi** testa a taglio  
Maxi Cutting Head Safety Spring

cod.	L	descriz.   descrip.
<b>MGT.2170</b>	170mm	grezza (brut)
<b>MVT.2170</b>	170mm	verniciata (painted)
<b>MFT.2170</b>	170mm	floccata (flocked)
<b>MGT.2190</b>	190mm	grezza (brut)
<b>MVT.2190</b>	190mm	verniciata (painted)
<b>MFT.2190</b>	190mm	floccata (flocked)

**Dati tecnici | Technical data:**

**saldatura 4 punti | 4 points welding**

**materiale | material**  
acciaio inox + alluminio |  
inox stainless steel + aluminium



**500 p**

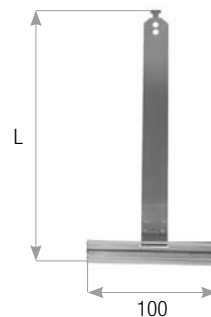
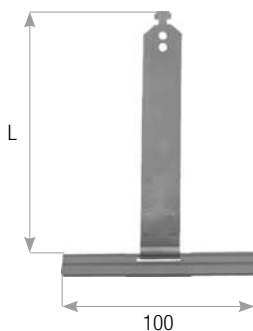

Molla di sicurezza **mini** testa a martello  
Mini Hammer Head Safety Spring

cod.	L	descriz.   descrip.
<b>MGM.1130</b>	130mm	grezza (brut)
<b>MVM.1130</b>	130mm	verniciata (painted)
<b>MFM.1130</b>	130mm	floccata (flocked)
<b>MGM.1170</b>	170mm	grezza (brut)
<b>MVM.1170</b>	170mm	verniciata (painted)
<b>MFM.1170</b>	170mm	floccata (flocked)

**Dati tecnici | Technical data:**

**saldatura 4 punti | 4 points welding**

**materiale | material**  
acciaio inox + alluminio |  
inox stainless steel + aluminium



**500 p**

Molla di sicurezza **maxi** testa a martello  
Maxi Hammer Head Safety Spring

cod.	L	descriz.   descrip.
<b>MGM.2170</b>	170mm	grezza (brut)
<b>MVM.2170</b>	170mm	verniciata (painted)
<b>MFM.2170</b>	170mm	floccata (flocked)
<b>MGM.2190</b>	190mm	grezza (brut)
<b>MVM.2190</b>	190mm	verniciata (painted)
<b>MFM.2190</b>	190mm	floccata (flocked)

**Dati tecnici | Technical data:**

**saldatura 4 punti | 4 points welding**

**materiale | material**  
acciaio inox + alluminio |  
inox stainless steel + aluminium



**500 p**

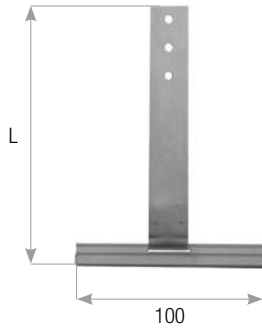

Molla di sicurezza **mini** testa a fori  
Mini Drilled Head Safety Spring

**Dati tecnici | Technical data:**

**saldatura 4 punti | 4 points welding**

**materiale | material**  
acciaio inox + alluminio |  
inox stainless steel + aluminium



**500 p**

cod.	L	descriz.   descrip.
<b>MGF.1130</b>	130mm	grezza (brut)
<b>MVF.1130</b>	130mm	verniciata (painted)
<b>MFF.1130</b>	130mm	floccata (flocked)
<b>MGF.1170</b>	170mm	grezza (brut)
<b>MVF.1170</b>	170mm	verniciata (painted)
<b>MFF.1170</b>	170mm	floccata (flocked)

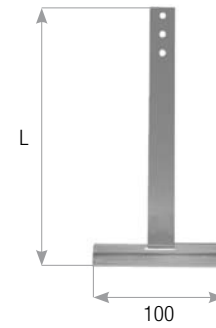

Molla di sicurezza **maxi** testa a fori  
Maxi Drilled Head Safety Spring

**Dati tecnici | Technical data:**

**saldatura 4 punti | 4 points welding**

**materiale | material**  
acciaio inox + alluminio |  
inox stainless steel + aluminium



**500 p**

cod.	L	descriz.   descrip.
<b>MGF.2170</b>	170mm	grezza (brut)
<b>MVF.2170</b>	170mm	verniciata (painted)
<b>MFF.2170</b>	170mm	floccata (flocked)
<b>MGF.2190</b>	190mm	grezza (brut)
<b>MVF.2190</b>	190mm	verniciata (painted)
<b>MFF.2190</b>	190mm	floccata (flocked)

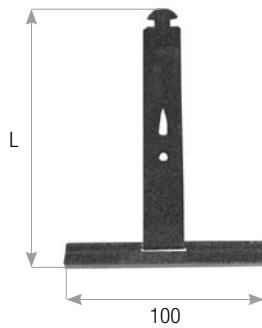

**doppia floccatura |**  
**double flocked**

**MFT.1130**

Molla di sicurezza testa a taglio floccata  
Flocked Cutting Head Safety Spring

**Dati tecnici | Technical data:**

**saldatura 4 punti | 4 points welding**

**materiale | material**  
acciaio inox + alluminio |  
inox stainless steel + aluminium



**500 p**

cod.	L	descriz.   descrip.
<b>MFT.1130</b>	130mm	taglio (cutting)
<b>MFT.1170</b>	170mm	taglio (cutting)
<b>MFT.2170</b>	170mm	taglio (cutting)
<b>MFT.2190</b>	190mm	taglio (cutting)

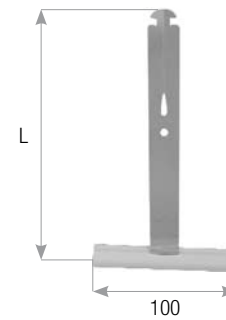

Molla sicurezza **mini** testa a taglio (ABS)  
Mini Hammer Head Safety Spring (ABS)

**Dati tecnici | Technical data:**

**saldatura 4 punti | 4 points welding**

**materiale | material**  
acciaio inox + alluminio |  
inox stainless steel + aluminium



**500 p**

cod.	L	descriz.   descrip.
<b>MPT.1130</b>	170mm	taglio (cutting)
<b>MPM.1130</b>	170mm	martello (hammer)
<b>MPF.1130</b>	170mm	fori (drilled)
<b>MPT.1170</b>	190mm	taglio (cutting)
<b>MPM.1170</b>	190mm	martello (hammer)
<b>MPF.1170</b>	190mm	fori (drilled)

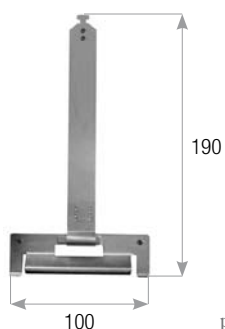

 per profili PVC  
for PVC profile

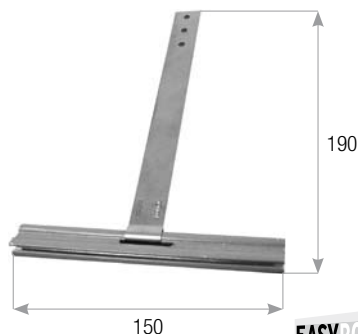





### MGM.G170

Molla di sicurezza martello, PVC  
Hammer Security Spring, PVC



50 p

#### Dati tecnici | Technical data:

**largh./lungh. | width/height** **materiale | material**  
100 x 190 mm inox+alluminio | inox + aluminium

### MGF.3190

Molla di sicurezza 190mm con fori  
Drilled Head Safety Spring



50 p

#### Dati tecnici | Technical data:

**largh./lungh. | width/height** **materiale | material**  
150 x 190mm inox+alluminio | inox + aluminium

### ALU TANK

cod.	rullo   roll	elementi   elements
ST.60.5	60mm	5
ST.70.5	70mm	5
ST.60.7	60mm	7
ST.70.7	70mm	10



20 p

**materiale | material** **larghezza | width**  
alluminio | aluminium 100mm

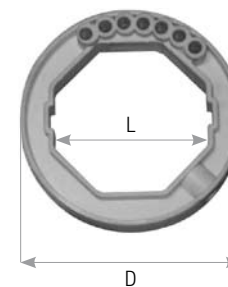
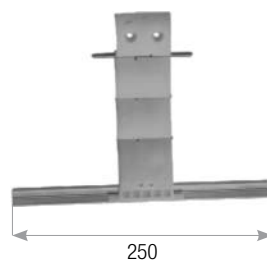
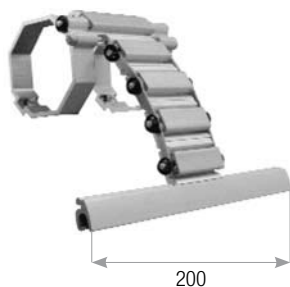

### ALU TANK 200mm

cod.	rullo   roll	elementi   elements
STL.60.5	60mm	5
STL.70.5	70mm	5
STL.60.7	60mm	7
STL.70.7	60mm	10



50 p

**materiale | material** **larghezza | width**  
alluminio | aluminium 200mm

### SYSTEM TANK

cod.	L	elementi   elements
ST.2.3	250mm	3
ST.2.4	250mm	4



50 p

**materiale | material** **larghezza | width**  
nylon | nylon 250mm

Anello adattatore per system tank  
Adapter Ring for System Tank



100 p

#### cod. per rullo | for roll

**AA.60** rullo ottagonale (octagonal roll) 60mm  
**AA.70** rullo ottagonale (octagonal roll) 70mm

**D:** 88mm / 104mm  
**spess. | thickness:** 14mm

**materiale | material**  
nylon | nylon

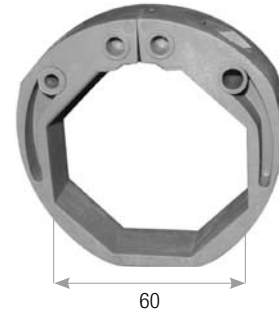
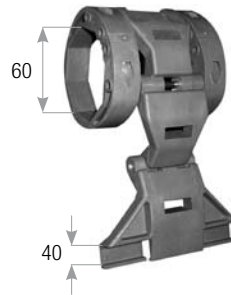
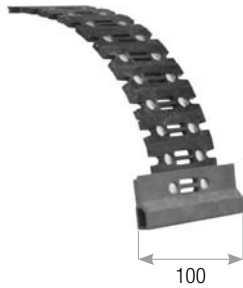

### SECURE TANK

cod.	L	elementi   elements
ST.1.7	100mm	7
ST.1.10	100mm	10



50 p

**materiale | material**  
nylon | nylon

**larghezza | width**  
100mm

### STG.1.3 STG.1.4 - 4 element. ✦

Tank a 3 elementi, 14mm  
3 Elements Tank, 14mm



50 p

**Dati tecnici | Technical data:**

**materiale | material**  
nylon | nylon

### AA.60.STG ✦

Anello adattatore per tank  
Tank Adapter Ring



100 p

**Dati tecnici | Technical data:**

**Ø esterno | Ø external**  
80mm

**materiale | material**  
nylon | nylon

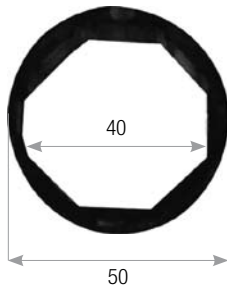

### AA.40.50

Anello adattatore per rullo ottagonale 40mm  
Adapter Ring for 40mm Octagonal Roll

**Dati tecnici | Technical data:**



100 p

**D esterno | D External**  
50mm

**materiale | material**  
nylon | nylon

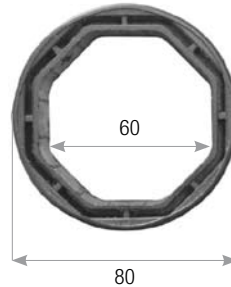

### AA.60.80

Anello adattatore per rullo ottagonale 60mm  
Adapter Ring for 60mm Octagonal Roll

**Dati tecnici | Technical data:**



100 p

**D esterno | D External**  
80mm

**materiale | material**  
nylon | nylon

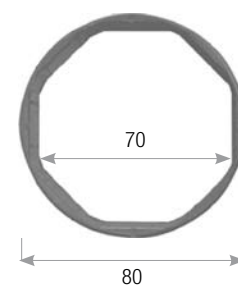

### AA.70.80

Anello adattatore per rullo ottagonale 70mm  
Adapter Ring for 70mm Octagonal Roll

**Dati tecnici | Technical data:**



100 p

**D esterno | D External**  
80mm

**materiale | material**  
nylon | nylon

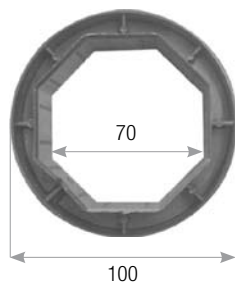

**AA.70.100**

Anello adattatore per rullo ottagonale 70mm  
Adapter Ring for 70mm Octagonal Roll

**Dati tecnici | Technical data:**

**D esterno | D External** 100mm  
**materiale | material** nylon | nylon



**100 p**

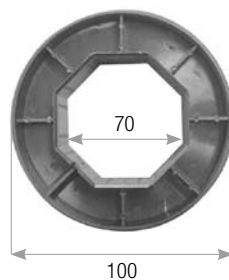

**AA.70.130**

Anello adattatore per rullo ottagonale 70mm  
Adapter Ring for 70mm Octagonal Roll

**Dati tecnici | Technical data:**

**D esterno | D External** 130mm  
**materiale | material** nylon | nylon



**100 p**



**AA.102.120**

Anello adattatore per rullo ottagonale 102mm  
Adapter Ring for 102mm Octagonal Roll

**cod. Ø int./est. | Ø int./ext**

**AA.102.120** 102mm | 120mm  
**materiale | material** nylon | nylon



**10 p**



**AA.102.130**

Anello adattatore per rullo ottagonale 102mm  
Adapter Ring for 102mm Octagonal Roll

**cod. Ø int./est. | Ø int./ext**

**AA.102.130** 102mm | 130mm  
**materiale | material** nylon | nylon



**10 p**

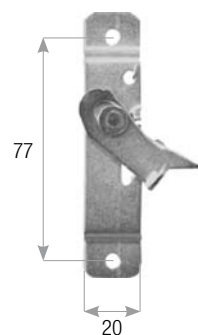

**CS.70**

Catenaccio di sicurezza  
Safety Latch

**Dati tecnici | Technical data:**

**utilizzo | use by** a coppia | pair  
**materiale | material** acciaio zincato | galvanised steel



**250 p**



**CS.12**

Catenaccio per profilo di tapparella  
Flat Blind Bolt

**Dati tecnici | Technical data:**

**utilizzo | use by** a coppia | pair  
**materiale | material** acciaio zincato | galvanised steel



**200 p**

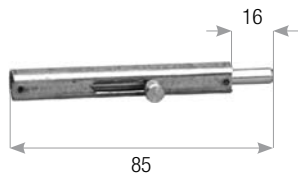

### CS.80

Catenaccio per profilo tapparella plastica  
Plastic Flat Blind Bolt



100 p

#### Dati tecnici | Technical data:

**utilizzo | use by**  
a coppia | pair

**materiale | material**  
acciaio zincato | galvanised steel

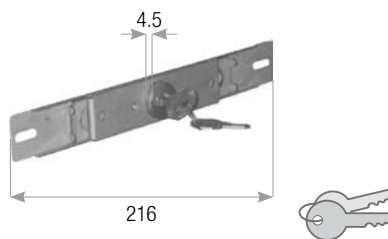

### SR.01

Serratura profili alluminio min. ingombro  
Cylinder Locks



250 p

#### Dati tecnici | Technical data:

**larghezza/altezza | width/height:** 27 x 216mm  
**materiale | material:** acciaio zincato | galvanised steel

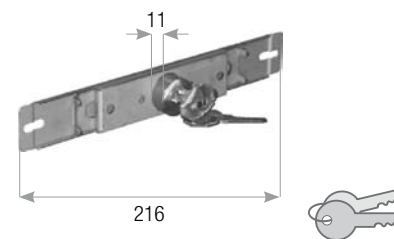

### SR.02

Serratura per profili in alluminio  
Cylinder Locks



250 p

#### Dati tecnici | Technical data:

**larghezza/altezza | width/height:** 27 x 216mm  
**materiale | material:** acciaio zincato | galvanised steel

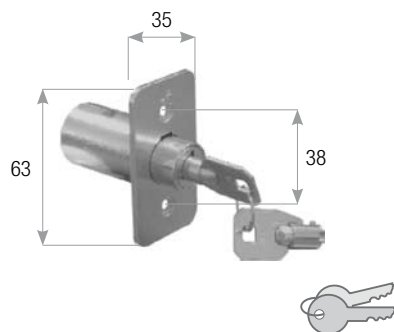

### SR.03

Serratura per garage-box interni  
Garage Locks



50 p

#### Dati tecnici | Technical data:

**larghezza/altezza | width/height:** 35 x 63mm  
**materiale | material:** acciaio zincato | galvanised steel